

## IGBT

### Features

- 600V,30A
- $V_{CE(sat)(typ.)}=1.9V@V_{GE}=15V,I_C=30A$
- High speed switching
- Higher system efficiency
- Soft current turn-off waveforms

### General Description

JIAEN Trench IGBTs offer lower losses and higher energy efficiency for application such as SMPS, general inverter and other soft switching applications.

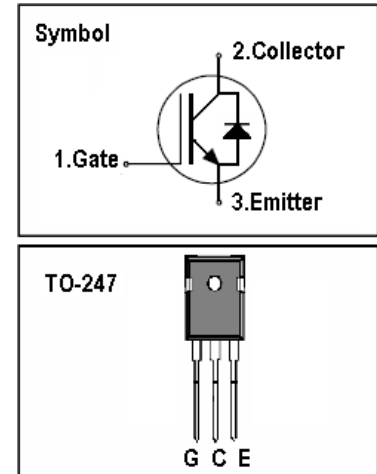

### Absolute Maximum Ratings

| Symbol    | Parameter  | Value       | Units      |
|-----------|--|-------------|------------|
| $V_{CES}$ | Collector-Emitter Voltage                              | 600         | V          |
| $V_{GES}$ | Gate-Emitter Voltage                                   | $\pm 30$    | V          |
| $I_C$     | Continuous Collector Current ( $T_C=25^\circ C$ )      | 80          | A          |
|           | Continuous Collector Current ( $T_C=100^\circ C$ )     | 30          | A          |
| $I_{CM}$  | Pulsed Collector Current (Note 1)                      | 120         | A          |
| $I_F$     | Diode Continuous Forward Current ( $T_C=100^\circ C$ ) | 30          | A          |
| $I_{FM}$  | Diode Maximum Forward Current (Note 1)                 | 120         | A          |
| $t_{sc}$  | Short Circuit Withstand Time                           | 10          | us         |
| $P_D$     | Maximum Power Dissipation ( $T_C=25^\circ C$ )         | 300         | W          |
|           | Maximum Power Dissipation ( $T_C=100^\circ C$ )        | 120         | W          |
| $T_J$     | Operating Junction Temperature Range                   | -55 to +150 | $^\circ C$ |
| $T_{STG}$ | Storage Temperature Range                              | -55 to +150 | $^\circ C$ |

### Thermal Characteristics

| Symbol       | Parameter                                      | Max. | Units        |
|--------------|--|------|--------------|
| $R_{th j-c}$ | Thermal Resistance, Junction to case for IGBT  | 0.42 | $^\circ C/W$ |
| $R_{th j-c}$ | Thermal Resistance, Junction to case for Diode | 1.5  | $^\circ C/W$ |
| $R_{th j-a}$ | Thermal Resistance, Junction to Ambient        | 40   | $^\circ C/W$ |

**Electrical Characteristics** ( $T_C=25^\circ\text{C}$  unless otherwise noted)

| Symbol        | Parameter                            | Test Conditions  | Min. | Typ. | Max. | Units   |
|---------------|--------------------------------------|--|------|------|------|---------|
| $BV_{CES}$    | Collector-Emitter Breakdown Voltage  | $V_{GE}=0V, I_C=250\mu A$  | 600  | -    | -    | V       |
| $I_{CES}$     | Collector-Emitter Leakage Current    | $V_{CE}=600V, V_{GE}=0V$   | -    | -    | 100  | $\mu A$ |
| $I_{GES}$     | Gate Leakage Current, Forward        | $V_{GE}=30V, V_{CE}=0V$  | -    | -    | 100  | nA      |
|               | Gate Leakage Current, Reverse        | $V_{GE}=-30V, V_{CE}=0V$   | -    | -    | -100 | nA      |
| $V_{GE(th)}$  | Gate Threshold Voltage               | $V_{GE}=V_{CE}, I_C=250\mu A$  | 4.5  | -    | 6.5  | V       |
| $V_{CE(sat)}$ | Collector-Emitter Saturation Voltage | $V_{GE}=15V, I_C=30A$  | -    | 1.9  | 2.3  | V       |
| $Q_g$         | Total Gate Charge                    | $V_{CC}=480V$<br>$V_{GE}=15V$<br>$I_C=30A$   | -    | 105  |      | nC      |
| $Q_{ge}$      | Gate-Emitter Charge                  |  | -    | 33   |      | nC      |
| $Q_{gc}$      | Gate-Collector Charge                |  | -    | 72   |      | nC      |
| $t_{d(on)}$   | Turn-on Delay Time                   | $V_{CC}=300V$<br>$V_{GE}=15V$<br>$I_C=30A$<br>$R_G=28\Omega$<br>Inductive Load<br>$T_C=25^\circ\text{C}$ | -    | 64   | -    | ns      |
| $t_r$         | Turn-on Rise Time                    |  | -    | 76   | -    | ns      |
| $t_{d(off)}$  | Turn-off Delay Time                  |  | -    | 354  | -    | ns      |
| $t_f$         | Turn-off Fall Time                   |  | -    | 56   | -    | ns      |
| $E_{on}$      | Turn-on Switching Loss               |  | -    | 0.9  | -    | mJ      |
| $E_{off}$     | Turn-off Switching Loss              |  | -    | 0.85 | -    | mJ      |
| $E_{ts}$      | Total Switching Loss                 |  | -    | 1.75 | -    | mJ      |
| $C_{ies}$     | Input Capacitance                    | $V_{CE}=25V$<br>$V_{GE}=0V$<br>$f=100\text{kHz}$   | -    | 1395 | -    | pF      |
| $C_{oes}$     | Output Capacitance                   |  | -    | 68   | -    | pF      |
| $C_{res}$     | Reverse Transfer Capacitance         |  | -    | 26   | -    | pF      |

**Electrical Characteristics of Diode** ( $T_C=25^\circ\text{C}$  unless otherwise noted)

| Symbol   | Parameter                           | Test Conditions                                    | Min. | Typ. | Max. | Units |
|----------|-------------------------------------|--|------|------|------|-------|
| $V_F$    | Diode Forward Voltage               | $I_F=30A$  | -    | 1.4  | 2.4  | V     |
| $t_{rr}$ | Diode Reverse Recovery Time         | $V_{CE}=300V$<br>$I_F=30A$<br>$dI_F/dt=200A/\mu s$ | -    | 75   |      | ns    |
| $I_{rr}$ | Diode peak Reverse Recovery Current |  | -    | 6    |      | A     |
| $Q_{rr}$ | Diode Reverse Recovery Charge       |  | -    | 220  |      | nC    |

**Notes:**

1. Repetitive Rating: Pulse width limited by maximum junction temperature

## Typical Performance Characteristics

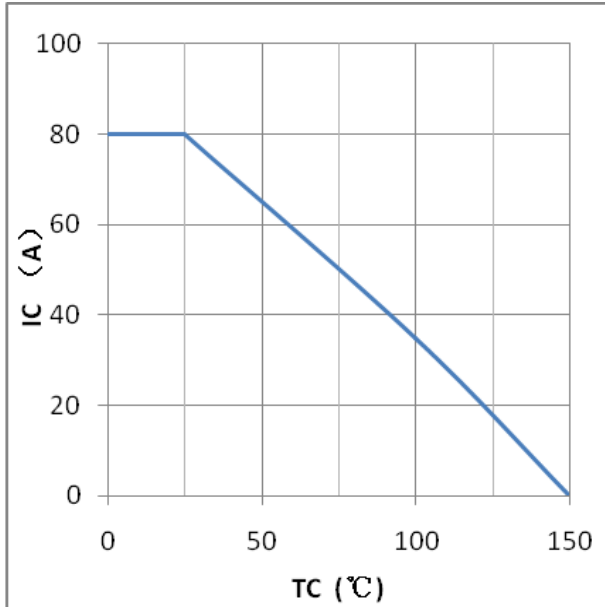

Figure1:maximum DC collector current VS. case temperature

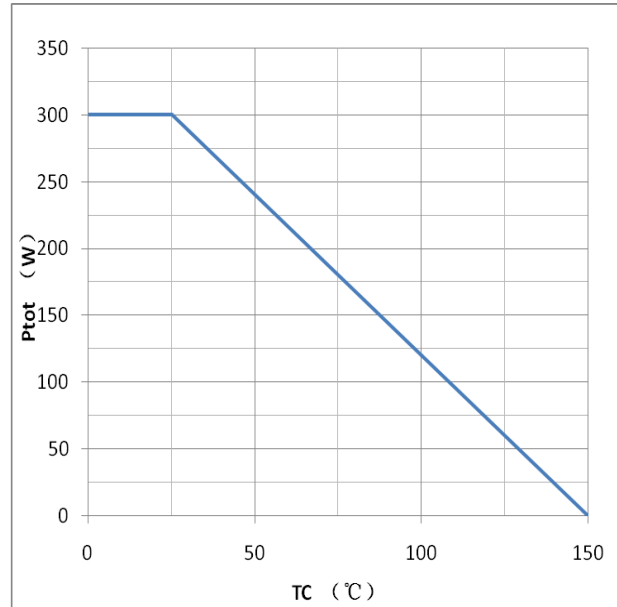

Figure2:power dissipation VS. case temprature

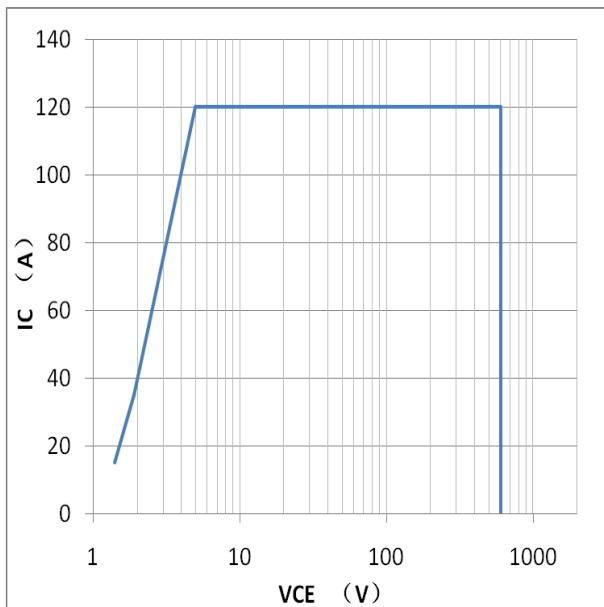

Figure3:reverse bias SOA,TJ=150°C,VGE=15V

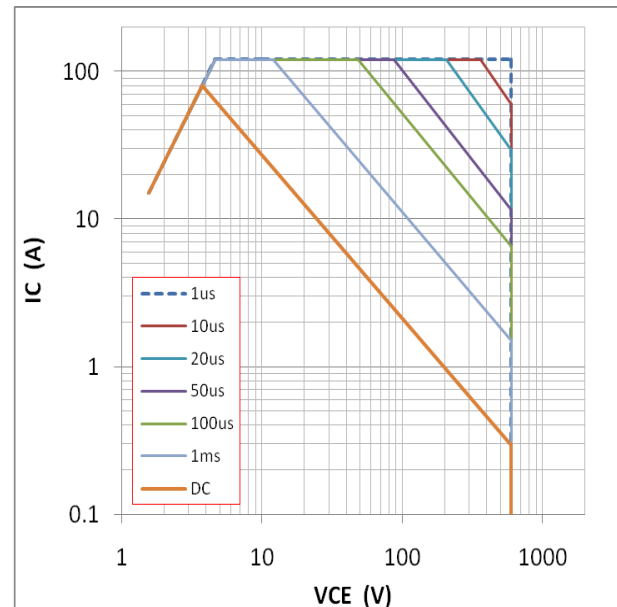

Figure4:forward SOA,TC=25°C,TJ≤150°C

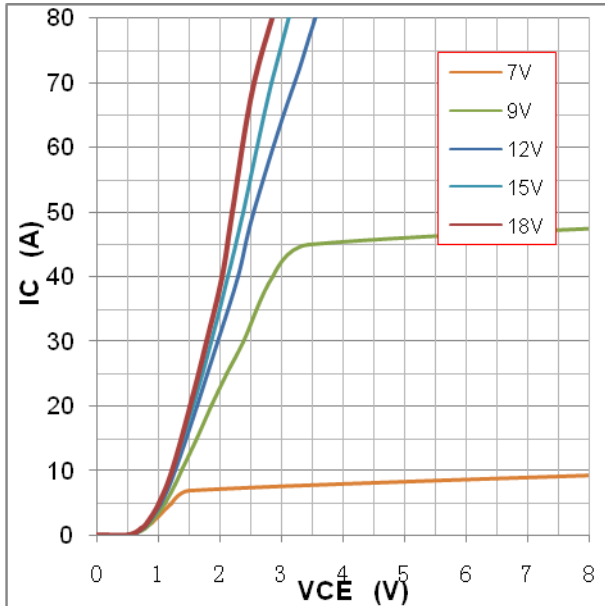

Figure5: typical IGBT output characteristics,  
 $T_J=25^{\circ}\text{C}; t_p=300\mu\text{s}$

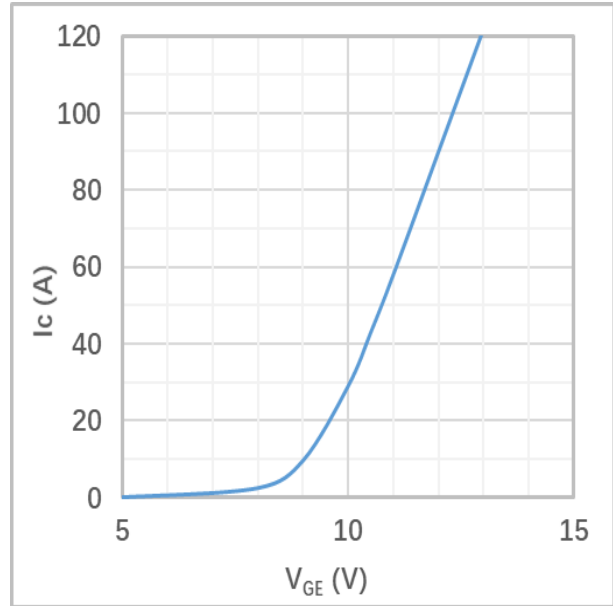

Figure6: typical trans characteristics,  $V_{CE}=20\text{V}, t_p=20\mu\text{s}$

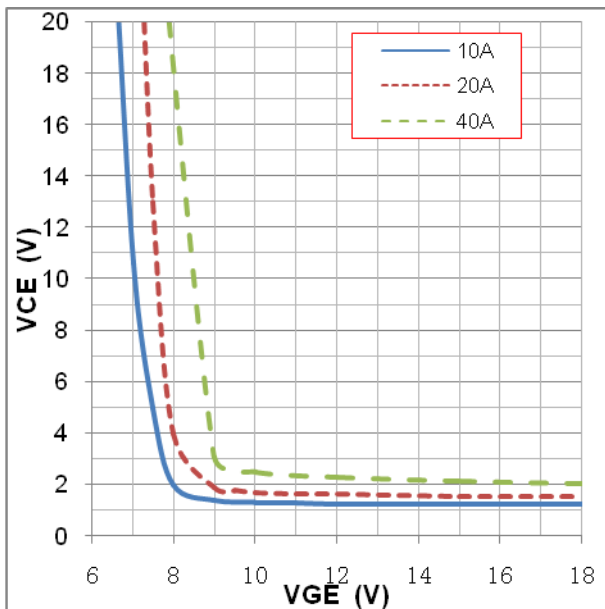

Figure7: typical VCE VS. VGE,  $T_J=25^{\circ}\text{C}$

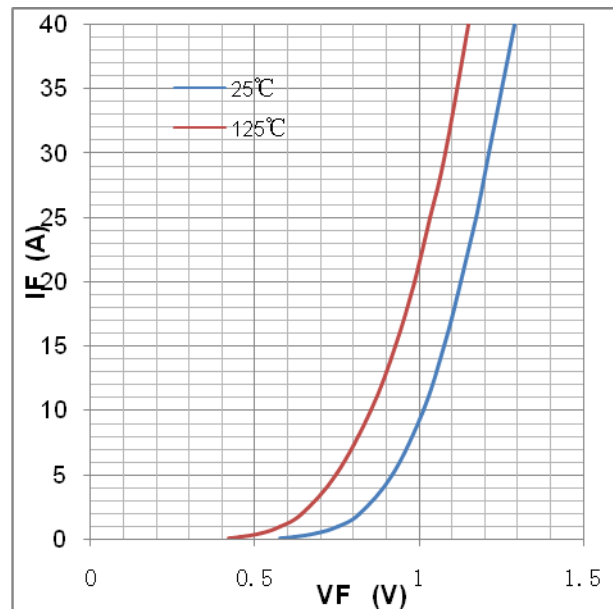

Figure8: typical diode forward characteristic,  $t_p=300\mu\text{s}$

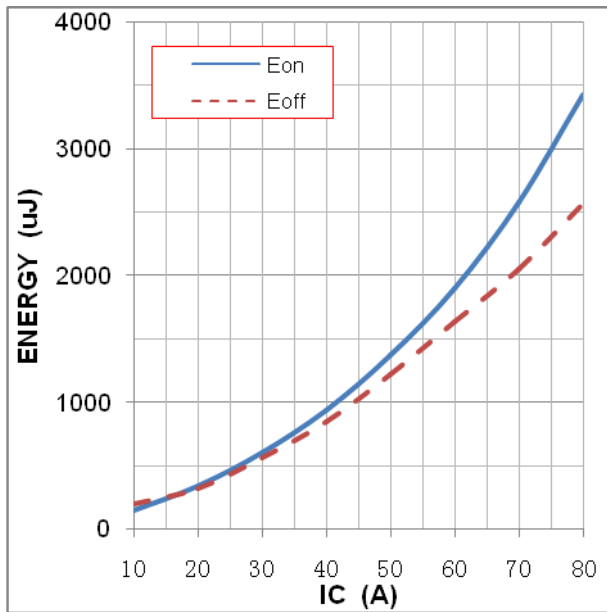

Figure9: typical energy loss VS. IC, TC=25°C,  
L=500uH, VCE=300V, VGE=15V, Rg=28 Ω,

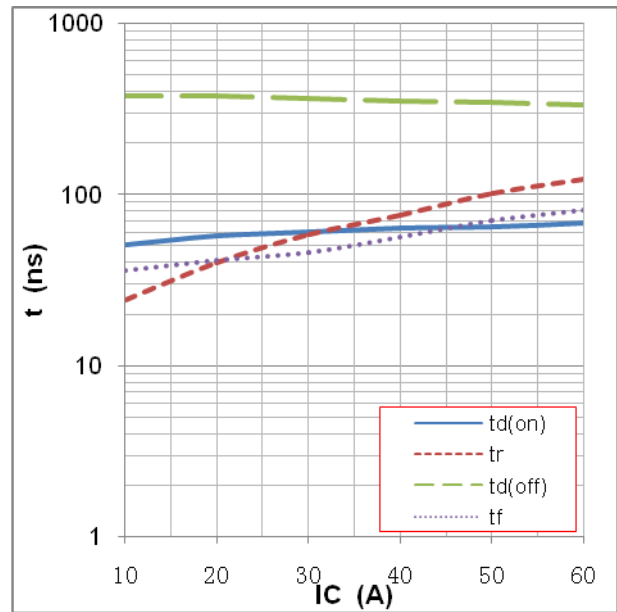

Figure10: typical switching time VS. IC, TC=25°C,  
L=500uH, VCE=300V, VGE=15V, Rg=28 Ω,

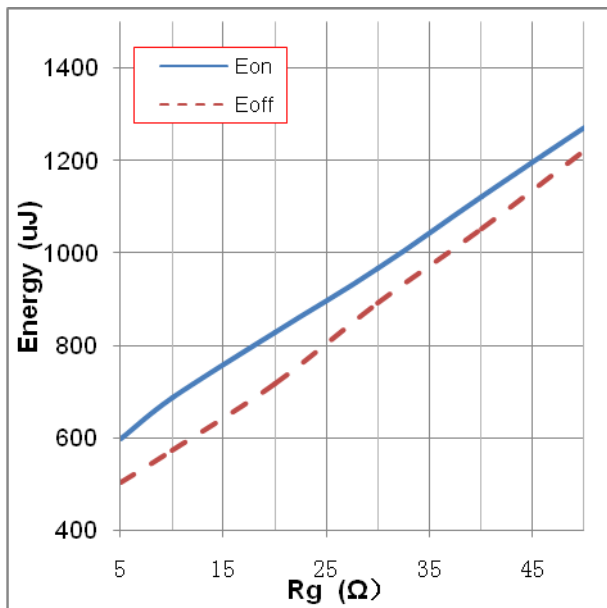

Figure11: typical energy loss VS. Rg, TC=25°C,  
L=500uH, VCE=300V, VGE=15V, IC=30A

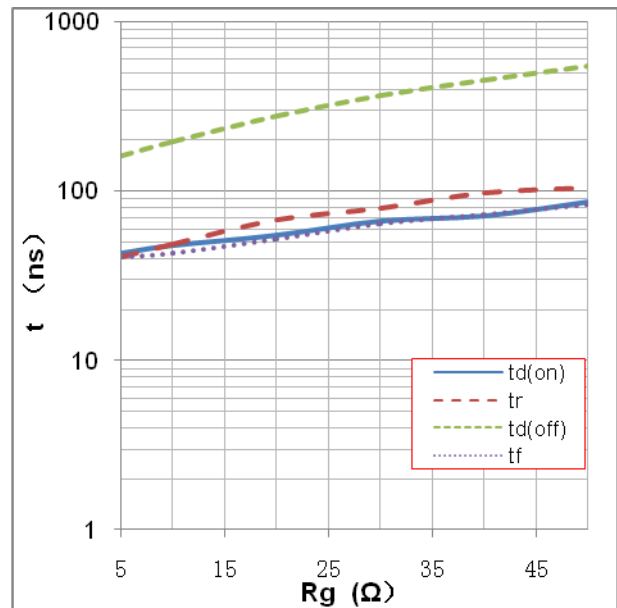

Figure12: typical switching time VS. Rg, TC=25°C,  
L=500uH, VCE=300V, VGE=15V, IC=30A

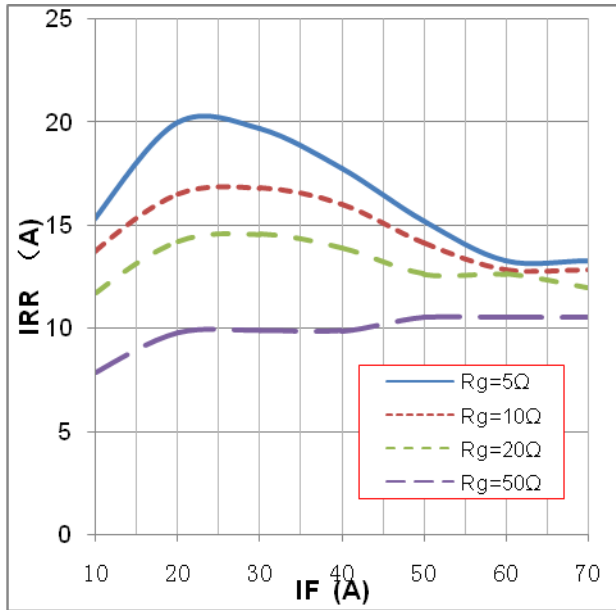

Figure13: typical diode IRR VS. IF, TC=25°C  
VCC=300V, VGE=15V

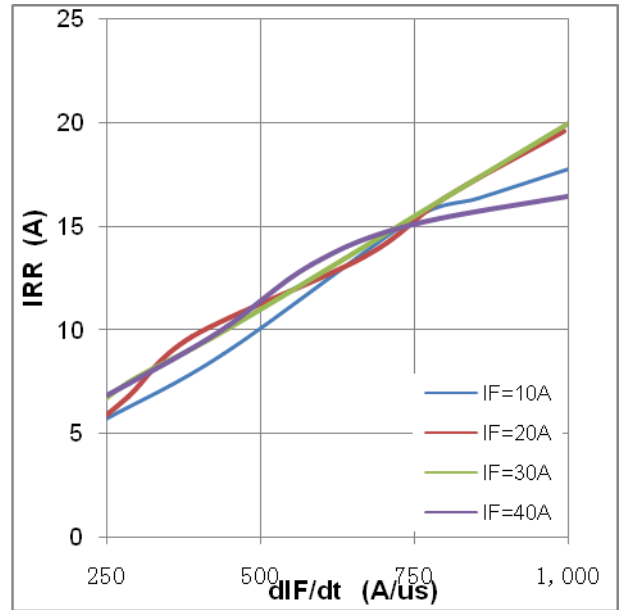

Figure14: typical diode IRR VS. dIF/dt  
VCC=300V, VGE=15V

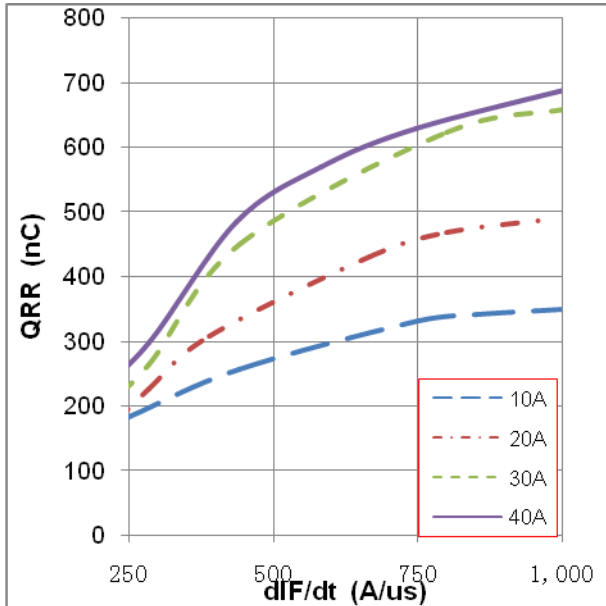

Figure15: typical diode QRR VS. dIF/dt  
VCC=300V, VGE=15V

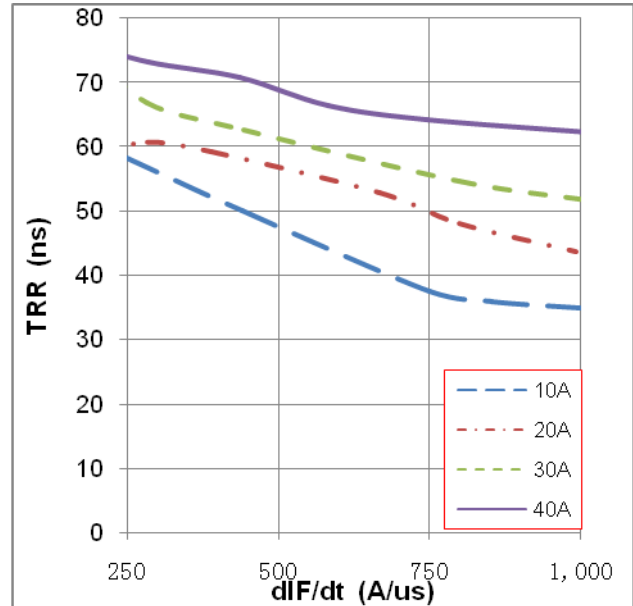

Figure16: typical diode TRR VS. dIF/dt,  
VCC=300V, VGE=15V

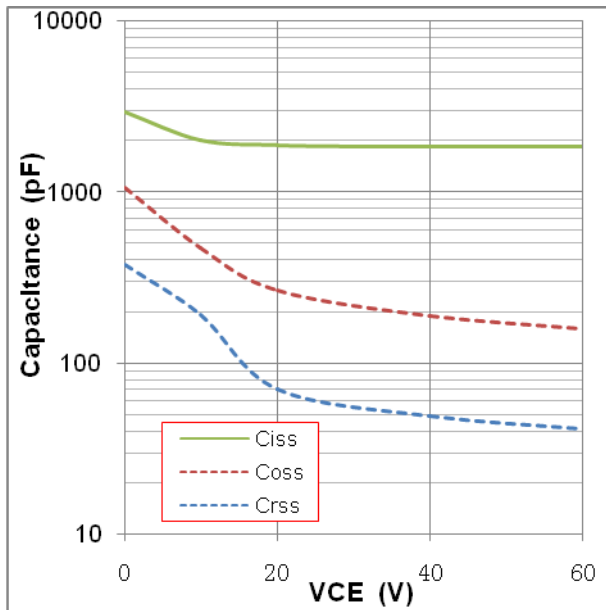

Figure17:typical capacitance VS. VCE,VGE=0V,f=100kHz

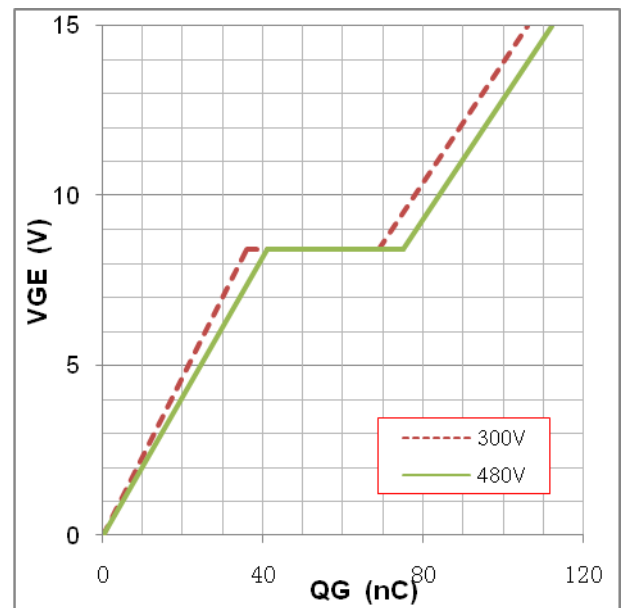

Figure18:typical gate charge VS. VGE,IC=30

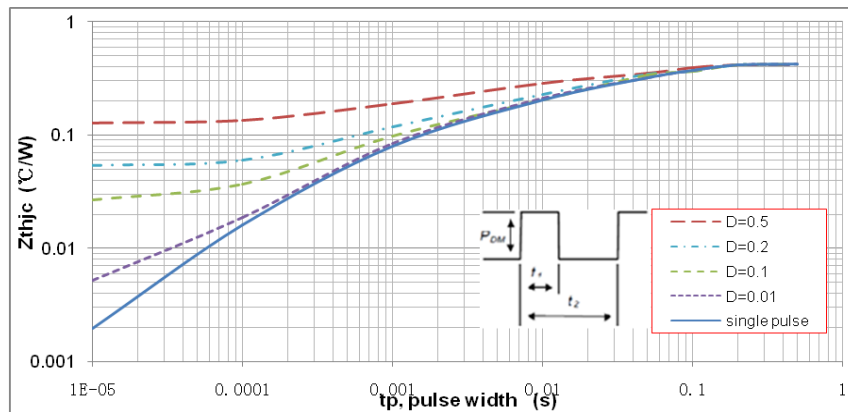
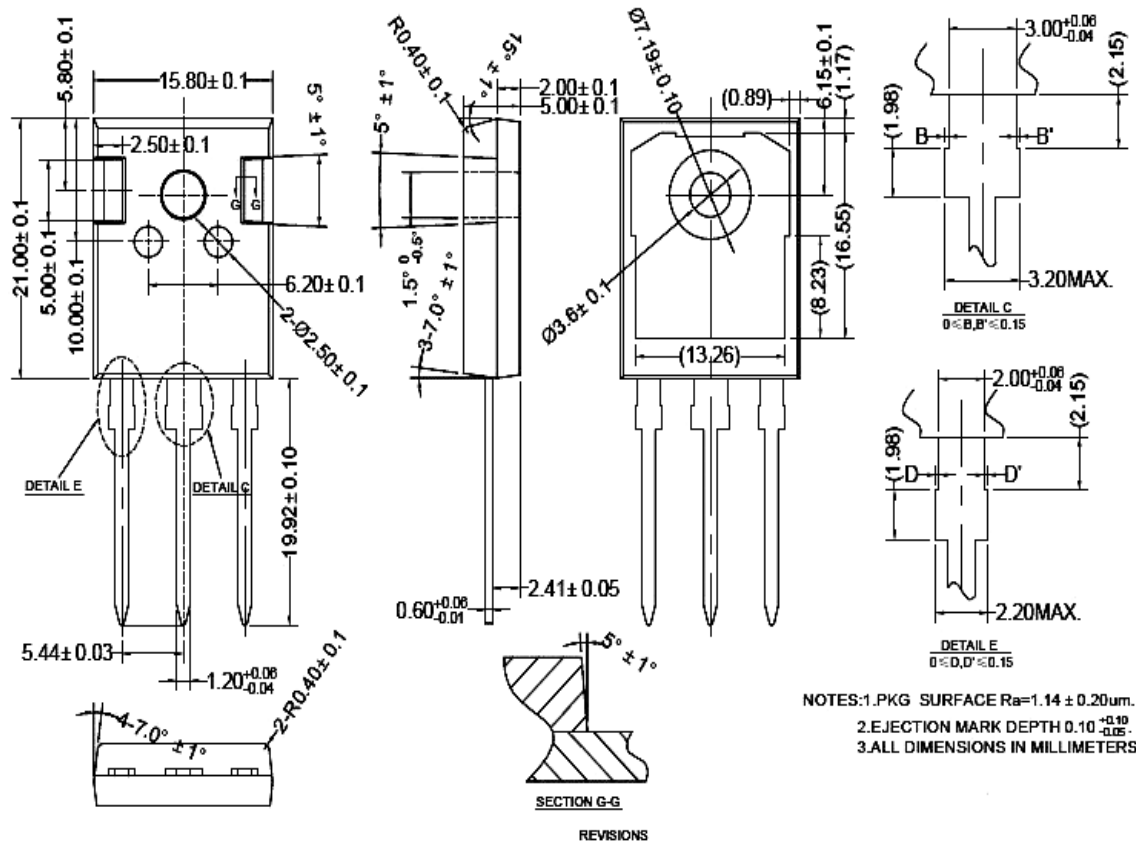

Figure19:normalised transient thermal impedance, junction-to-case

Note1.Duty factor  $D=t_1/t_2$ ; Note2:peak  $T_J=PDM \times Z_{thjc}+T_C$

TO247 PACKAGE OUTLINE



NOTES: 1. PKG SURFACE Ra=1.14 ± 0.20µm.  
2. EJECTION MARK DEPTH 0.10<sup>+0.10</sup>/<sub>-0.05</sub>.  
3. ALL DIMENSIONS IN MILLIMETERS.

0 ≤ D, D' ≤ 0.15

NOTES: 1. PKG SURFACE Ra=1.14 ± 0.20µm.  
2. EJECTION MARK DEPTH 0.10<sup>+0.10</sup>/<sub>-0.05</sub>.  
3. ALL DIMENSIONS IN MILLIMETERS.

| 公差标注   | 公差值    | 表面粗糙度     |
|--------|--------|-----------|
| 0      | ±0.2   | Ra3.2~6.3 |
| 0.0    | ±0.1   | Ra1.6~3.2 |
| 0.00   | ±0.01  | Ra0.8~1.6 |
| 0.000  | ±0.005 | Ra0.4~0.8 |
| 0.0000 | ±0.002 | Ra0.2~0.4 |



## **Disclaimers**

JIAEN Semiconductor Co., Ltd reserves the right to make changes without notice in order to improve reliability, function or design and to discontinue any product or service without notice. Customers should obtain the latest relevant information before orders and should verify that such information is current and complete. All products are sold subject to JIAEN's terms and conditions supplied at the time of order acknowledgement.

JIAEN Semiconductor Co., Ltd warrants performance of its hardware products to the specifications at the time of sale, Testing, reliability and quality control are used to the extent JIAEN deems necessary to support this warrantee. Except where agreed upon by contractual agreement, testing of all parameters of each product is not necessarily performed.

JIAEN Semiconductor Co., Ltd does not assume any liability arising from the use of any product or circuit designs described herein. Customers are responsible for their products and applications using JIAEN's components. To minimize risk, customers must provide adequate design and operating safeguards.

JIAEN Semiconductor Co., Ltd does not warrant or convey any license either expressed or implied under its parent rights, nor the rights of others. Reproduction of information in JIAEN's datasheets or data books is permissible only if reproduction is without modification or alteration. Reproduction of this information with any alteration is an unfair and deceptive business practice. JIAEN Semiconductor Co., Ltd is not responsible or liable for such altered documentation.

Resale of JIAEN's products with statements different from or beyond the parameters stated by JIAEN Semiconductor Co., Ltd for that product or service voids all express or implied warranties for the associated JIAEN's product or service and is unfair and deceptive business practice. JIAEN Semiconductor Co., Ltd is not responsible or liable for any such statements.