

IGBT

Features

- 600V,25A
- $V_{CE(sat)(typ.)}=2.1V@V_{GE}=15V,I_C=25A$
- High speed switching
- Higher system efficiency
- Soft current turn-off waveforms
- Square RBSOA

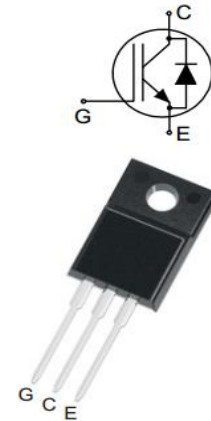

General Description

JIAEN Trench IGBTs offer lower losses and higher energy efficiency for application such as SMPS, general inverter and other switching applications.

Absolute Maximum Ratings

Symbol	Parameter	Value	Units
V_{CES}	Collector-Emitter Voltage	600	V
V_{GES}	Gate-Emitter Voltage	± 30	V
I_C	Continuous Collector Current ($T_C=25^\circ C$)	45	A
	Continuous Collector Current ($T_C=100^\circ C$)	25	A
I_{CM}	Pulsed Collector Current (Note 1)	75	A
I_F	Diode Continuous Forward Current ($T_C=100^\circ C$)	25	A
I_{FM}	Diode Maximum Forward Current (Note 1)	75	A
t_{sc}	Short Circuit Withstand Time	10	us
P_D	Maximum Power Dissipation ($T_C=25^\circ C$)	42	W
	Maximum Power Dissipation ($T_C=100^\circ C$)	17	W
T_J	Operating Junction Temperature Range	-55 to +150	$^\circ C$
T_{STG}	Storage Temperature Range	-55 to +150	$^\circ C$

Thermal Characteristics

Symbol	Parameter	Max.	Units
$R_{th\ j-c}$	Thermal Resistance, Junction to case for IGBT	3.0	$^\circ C/W$
$R_{th\ j-c}$	Thermal Resistance, Junction to case for Diode	2.9	$^\circ C/W$
$R_{th\ j-a}$	Thermal Resistance, Junction to Ambient	65	$^\circ C/W$

Electrical Characteristics ($T_C=25^\circ\text{C}$ unless otherwise noted)

Symbol	Parameter	Test Conditions	Min.	Typ.	Max.	Units
BV_{CES}	Collector-Emitter Breakdown Voltage	$V_{GE}=0V, I_C=250\mu A$	600	-	-	V
I_{CES}	Collector-Emitter Leakage Current	$V_{CE}=600V, V_{GE}=0V$	-	-	100	μA
I_{GES}	Gate Leakage Current, Forward	$V_{GE}=30V, V_{CE}=0V$	-	-	100	nA
	Gate Leakage Current, Reverse	$V_{GE}=-30V, V_{CE}=0V$	-	-	100	nA
$V_{GE(th)}$	Gate Threshold Voltage	$V_{GE}=V_{CE}, I_C=250\mu A$	4.5	-	6.5	V
$V_{CE(sat)}$	Collector-Emitter Saturation Voltage	$V_{GE}=15V, I_C=25A$	-	2.1	2.6	V
Q_g	Total Gate Charge	$V_{CC}=400V$ $V_{GE}=15V$ $I_C=25A$	-	62		nC
Q_{ge}	Gate-Emitter Charge		-	8		nC
Q_{gc}	Gate-Collector Charge		-	32		nC
$t_{d(on)}$	Turn-on Delay Time	$V_{CC}=400V$ $V_{GE}=15V$ $I_C=25A$ $R_G=28\Omega$ Inductive Load $T_C=25^\circ\text{C}$	-	20	-	ns
t_r	Turn-on Rise Time		-	27	-	ns
$t_{d(off)}$	Turn-off Delay Time		-	200	-	ns
t_f	Turn-off Fall Time		-	24	-	ns
E_{on}	Turn-on Switching Loss		-	0.65	-	mJ
E_{off}	Turn-off Switching Loss		-	0.28	-	mJ
E_{ts}	Total Switching Loss		-	0.93	-	mJ
C_{ies}	Input Capacitance	$V_{CE}=25V$ $V_{GE}=0V$ $f=1\text{MHz}$	-	900	-	pF
C_{oes}	Output Capacitance		-	285	-	pF
C_{res}	Reverse Transfer Capacitance		-	70	-	pF

Electrical Characteristics of Diode ($T_C=25^\circ\text{C}$ unless otherwise noted)

Symbol	Parameter	Test Conditions	Min.	Typ.	Max.	Units
V_F	Diode Forward Voltage	$I_F=25A$	-	1.5	2.0	V
t_{rr}	Diode Reverse Recovery Time	$V_{CE}=400V$ $I_F=25A$ $di/dt=200A/\mu s$	-	85		ns
I_{rr}	Diode peak Reverse Recovery Current		-	14		A
Q_{rr}	Diode Reverse Recovery Charge		-	200		nC

Notes:

1. Repetitive Rating: Pulse width limited by maximum junction temperature

Typical Performance Characteristics

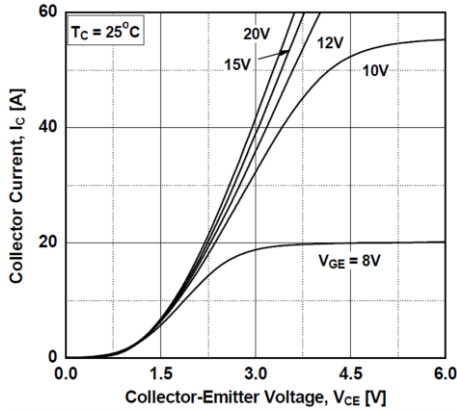

Fig 1. Output characteristics

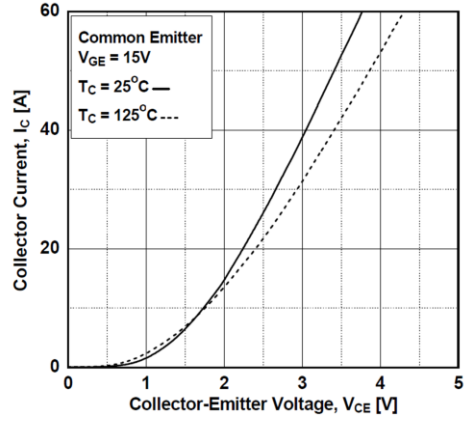

Fig 2. Typical Saturation Voltage Characteristics

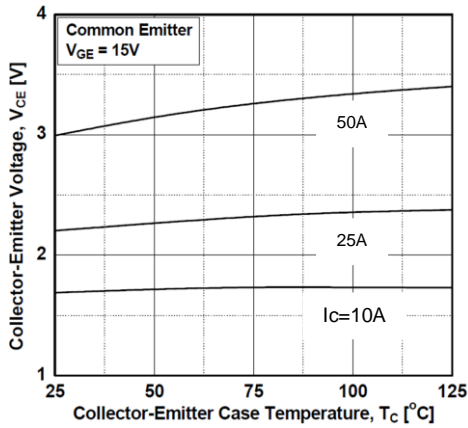

Figure 3. Saturation Voltage vs. Case Temperature at Variant Current Level

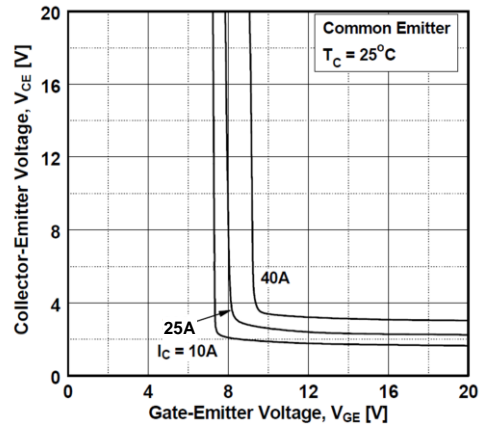

Figure 4. Saturation Voltage vs. V_{GE}

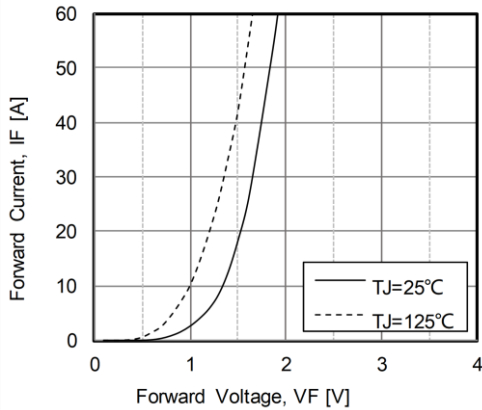

Figure 5. Forward Characteristics

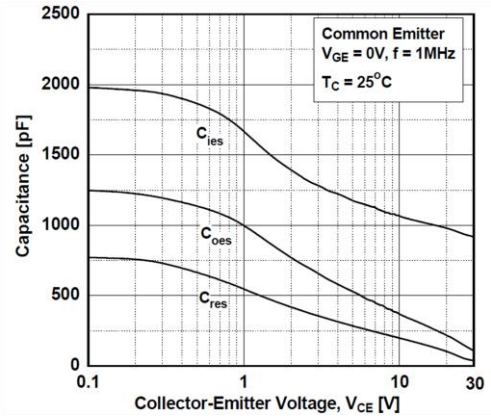

Figure 6. Capacitance Characteristics

Typical Performance Characteristics

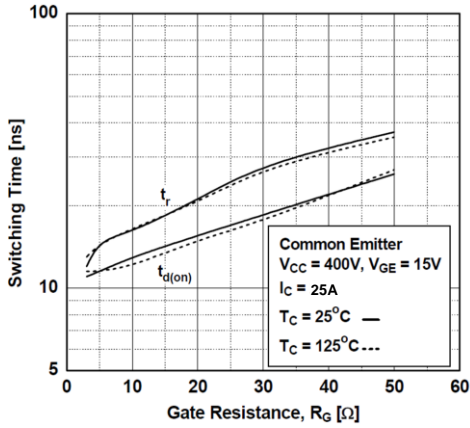

Figure 7. Turn-On Characteristics vs. Gate Resistance

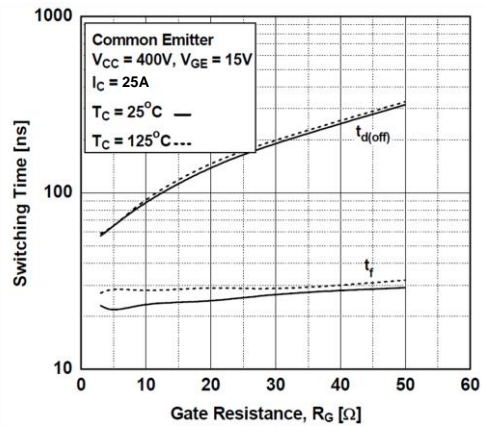

Figure 8. Turn-Off Characteristics vs. Gate Resistance

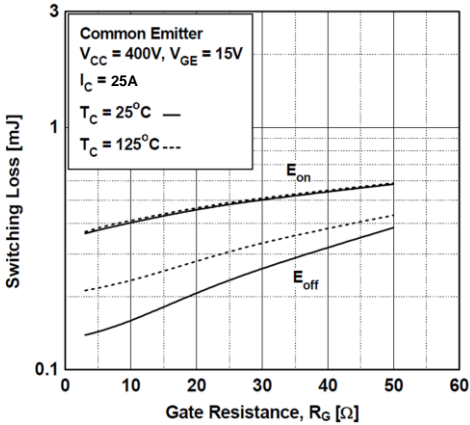

Figure 9. Switching Loss vs. Gate Resistance

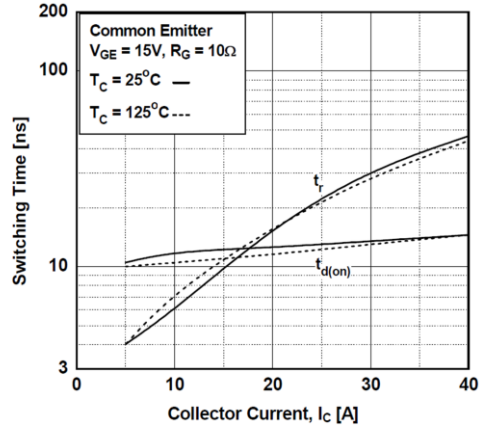

Figure 10. Turn-On Characteristics vs. Collector Current

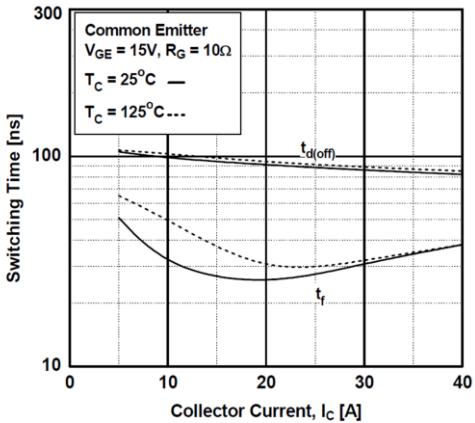

Figure 11. Turn-Off Characteristics vs. Collector Current

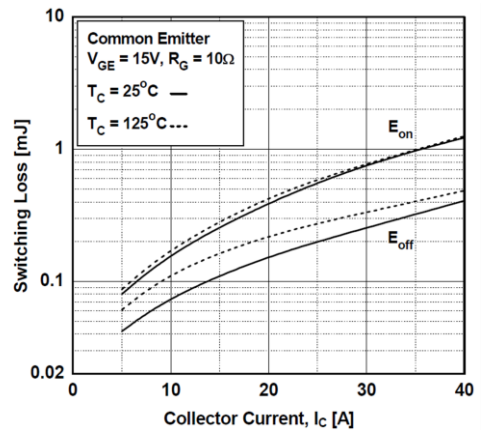

Figure 12. Switching Loss vs. Collector Current

Typical Performance Characteristics

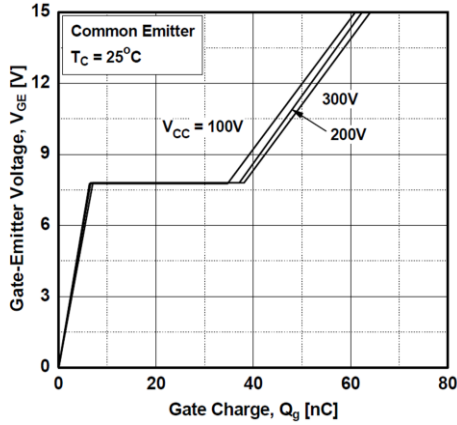

Figure 13. Gate Charge Characteristics

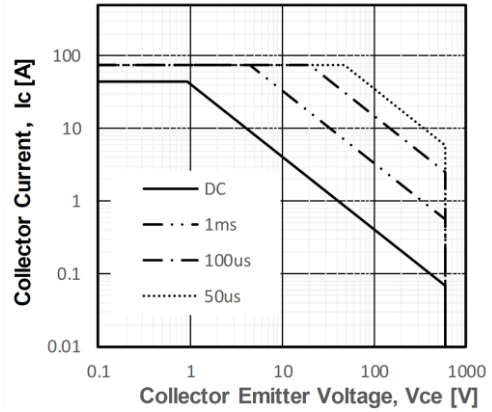

Figure 14. SOA Characteristics

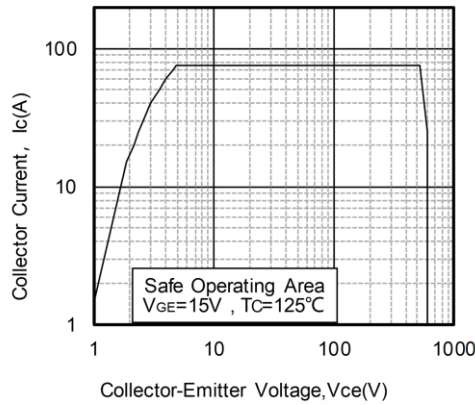

Figure 15. Turn-Off SOA

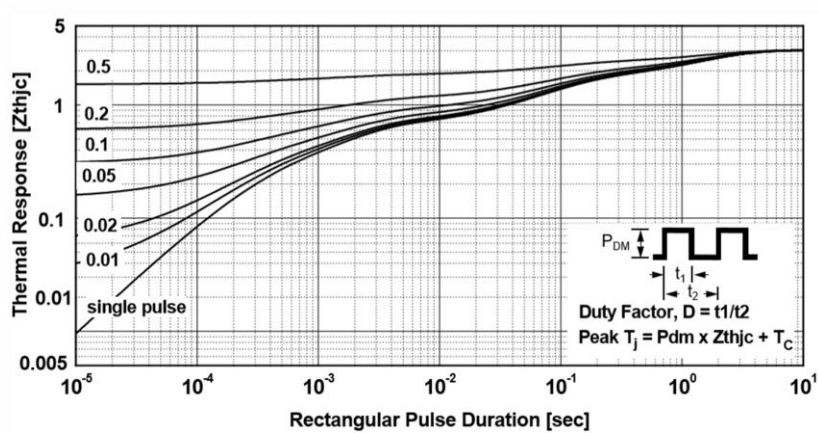
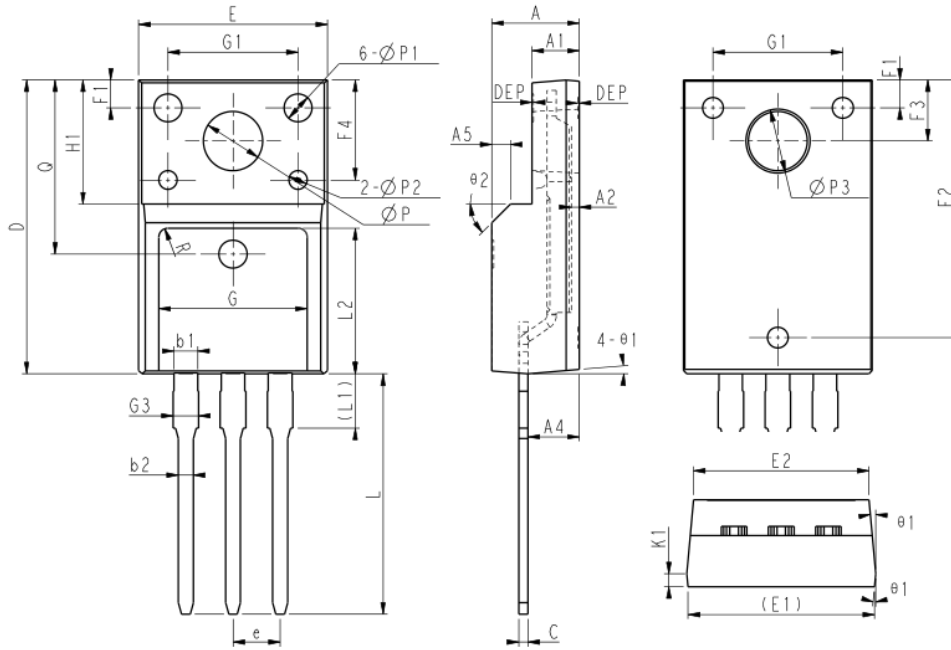

Figure 19. Transient Thermal Impedance of IGBT

封装外型



COMMON DIMENSIONS

SYMBOL	MM		
	MIN	NOM	MAX
E	10.00	10.16	10.32
E1	9.94	10.04	10.14
E2	9.36	9.46	9.56
A	4.50	4.70	4.90
A1	2.34	2.54	2.74
A2	0.43	-	0.48
A4	2.66	2.76	2.86
A5	-	1.00REF	-
e	0.45	0.50	0.60
D	15.67	15.87	16.07
Q	-	9.40REF	-
H1	-	6.70REF	-
e	-	2.54BSC	-
ΦP	-	3.18REF	-
L	12.78	12.98	13.18
L1	2.83	2.93	3.03
L2	7.70	7.80	7.90
ΦP1	1.40	1.50	1.60
ΦP2	0.95	1.00	1.05
ΦP3	-	3.45REF	-
θ 1	3°	5°	7°
θ 2	-	45°	-
DEP	0.05	0.10	0.15
F1	1.00	1.50	2.00
F2	13.80	13.90	14.00
F3	3.20	3.30	3.40
F4	5.30	5.40	5.50
G	7.80	8.00	8.20
G1	6.90	7.00	7.10
G3	1.25	1.35	1.45
b1	1.23	1.28	1.38
b2	0.75	0.80	0.90
K1	0.65	0.70	0.75
R	-	0.50REF	-

Disclaimers

JIAEN Semiconductor Co., Ltd reserves the right to make changes without notice in order to improve reliability, function or design and to discontinue any product or service without notice. Customers should obtain the latest relevant information before orders and should verify that such information is current and complete. All products are sold subject to JIAEN's terms and conditions supplied at the time of order acknowledgement.

JIAEN Semiconductor Co., Ltd warrants performance of its hardware products to the specifications at the time of sale, Testing, reliability and quality control are used to the extent JIAEN deems necessary to support this warrantee. Except where agreed upon by contractual agreement, testing of all parameters of each product is not necessarily performed.

JIAEN Semiconductor Co., Ltd does not assume any liability arising from the use of any product or circuit designs described herein. Customers are responsible for their products and applications using JIAEN's components. To minimize risk, customers must provide adequate design and operating safeguards.

JIAEN Semiconductor Co., Ltd does not warrant or convey any license either expressed or implied under its parent rights, nor the rights of others. Reproduction of information in JIAEN's datasheets or data books is permissible only if reproduction is without modification or alteration. Reproduction of this information with any alteration is an unfair and deceptive business practice. JIAEN Semiconductor Co., Ltd is not responsible or liable for such altered documentation.

Resale of JIAEN's products with statements different from or beyond the parameters stated by JIAEN Semiconductor Co., Ltd for that product or service voids all express or implied warranties for the associated JIAEN's product or service and is unfair and deceptive business practice. JIAEN Semiconductor Co., Ltd is not responsible or liable for any such statements.